

Product Category

Cardiovascular Products	2
Anesthesia & Respiration Products	20
Neurosurgical Products	30
General Surgical Products	34

CARDIOVASCULAR

PRODUCTS

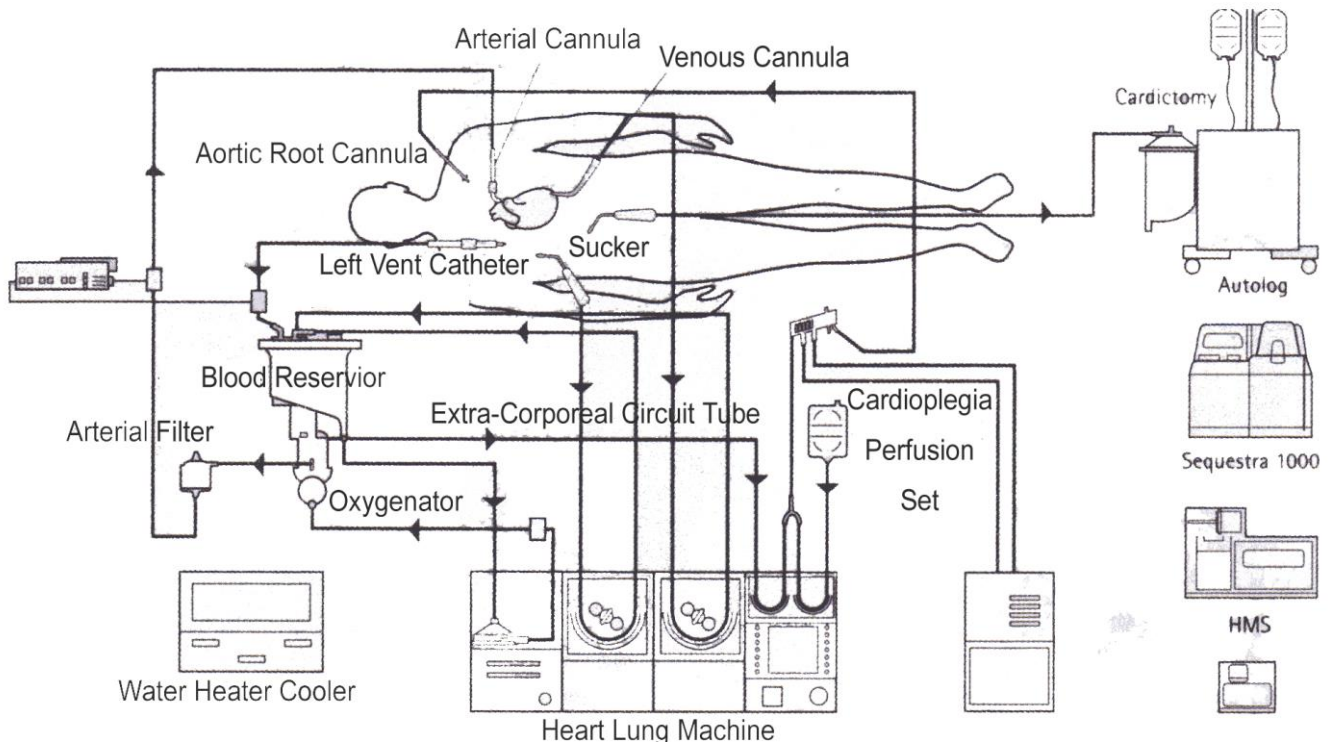

Arterial Cannula

CE 0123

Single piece body. Straight or Curved tip, available with connector acceptance, vented connector or non-vented connector. An adjustable or fixed depth ring together with tip and depth line permits precise position of all cannulae.

Pediatric - 20cm length		
Straight Tip	Curved Tip	
Code	Code	Specification
3421110	3422110	10Fr
3421112	3422112	12Fr
3421114	3422114	14Fr
3421116	3422116	16Fr
3421118	3422118	18Fr
Adult - 20cm length		
3421120	3422120	20Fr
3421122	3422122	22Fr
3421124	3422124	24Fr
3421126	3422126	26Fr



Injected Tip, Straight or Curved tip, available with connector acceptance, vented connector or non-vented connector. A fixed ring with tip and depth line permits precise position of cannula.

Pediatric - 20cm length		
Straight Tip	Curved Tip	
Code	Code	Specification
3421212	3422212	12Fr
3421214	3422214	14Fr
3421216	3422216	16Fr
3421218	3422218	18Fr
Adult - 20cm length		
3421220	3422220	20Fr
3421222	3422222	22Fr
3421224	3422224	24Fr
3421226	3422226	26Fr



Reinforced Arterial Cannula

Single piece and wire reinforced body. Straight or Curved tip, available with connector acceptance, vented connector or non-vented connector. A fixed ring with tip and depth line permits precise position of cannula.

Pediatric - 21cm length		
Straight Tip	Curved Tip	
Code	Code	Specification
3413116	3414116	16Fr
3413118	3414118	18Fr
Adult – 24cm length		
3413120	3414120	20Fr
3413122	3414122	22Fr
3413124	3414124	24Fr

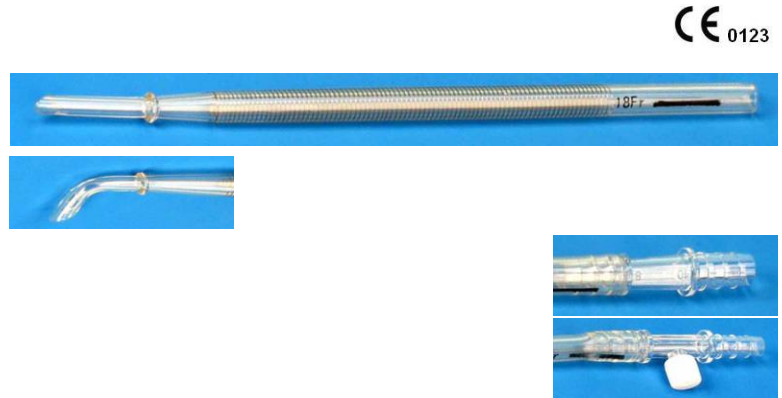

Injected Tip, Straight or Curved tip, available with connector acceptance, vented connector or non-vented connector. A fixed ring with tip and depth line permits precise position of cannula.

Pediatric - 20cm length		
Straight Tip	Curved Tip	
Code	Code	Specification
3411212	3412112	12Fr
3411214	3412114	14Fr
3411216	3412116	16Fr
3411218	3412118	18Fr
Adult – 20cm length		
3411220	3412120	20Fr
3411222	3412122	22Fr
3411224	3412124	24Fr
3411226	3412126	26Fr

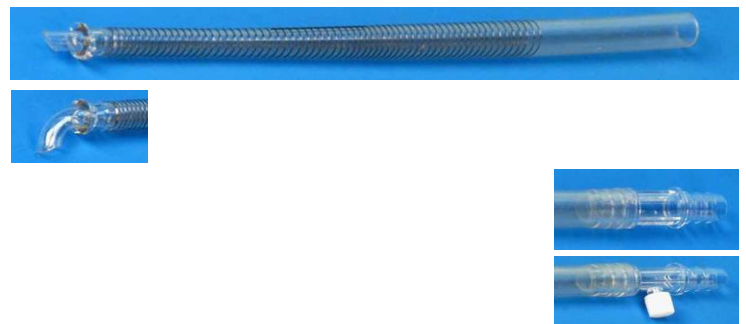

Pediatric One-Piece Arterial Cannula

CE 0123

These cannulae feature beveled, thin wall tips with elongated, one piece, kink resistant, wire reinforced bodies. This construction allows for higher flow rates with minimal pressure differential. An introducer along with depth markings permit precise positioning of the cannula.

Code	Specification
3431108	8Fr
3431110	10Fr
3431112	12Fr
3431114	14Fr
3431116	16Fr
3431118	18Fr



Extended Arterial Cannula

Code	Specification
344115	15Fr
344117	17Fr
344119	19Fr
344121	21Fr



Venous Cannula

CE 0123

Single piece body. Wire Reinforced.

Normal Body	Oval Body	
Code	Code	Specification
321212	323212	12Fr
321214	323214	14Fr
321216	323216	16Fr
321218	323218	18Fr
321220	323220	20Fr
321222	323222	22Fr
321224	323224	24Fr
321226	323226	26Fr
321228	323228	28Fr
321230	323230	30Fr
321232	323232	32Fr
321234	323234	34Fr
321236	323236	36Fr
321238	323238	38Fr
321240	323240	40Fr



Venous Cannula with Right Angle Metal Tip

CE 0123

These cannulae feature kink resistant, wire wound bodies with beveled metal, multi-port tips. This construction allows for higher flow rates with minimal pressure differential. A tip orientation line permits precise positioning of the cannulae.

Code	Specification
326112	12Fr
326114	14Fr
326116	16Fr
326118	18Fr
326120	20Fr
326122	22Fr
326124	24Fr
326126	26Fr
326128	28Fr
326130	30Fr
326132	32Fr
326134	34Fr



Venous Cannula with Right Angle Tip

Code	Specification
326212	12Fr
326214	14Fr
326216	16Fr
326218	18Fr
326220	20Fr
326222	22Fr
326224	24Fr
326226	26Fr
326228	28Fr
326230	30Fr
326232	32Fr
326234	34Fr
326236	36Fr
326238	38Fr



Venous Cannula with Right Angle Plastic Tip

Code	Specification
326308	8Fr
326310	10Fr
326312	12Fr
326314	14Fr
326316	16Fr
326318	18Fr
326320	20Fr
326322	22Fr
326324	24Fr
326326	26Fr
326328	28Fr
326330	30Fr



Two Stage Venous Cannula

CE 0123

Code	Specification
Normal Body	
322228/36	28/36Fr
322232/40	32/40Fr
322234/46	34/46Fr
322236/46	36/46Fr
322236/51	36/51Fr
Oval Body	
324228/36	28/36Fr
324232/40	32/40Fr
324234/46	34/46Fr
324236/46	36/46Fr
324236/51	36/51Fr
Screw Body	
325228/36	28/36Fr
325232/40	32/40Fr
325234/46	34/46Fr
325236/46	36/46Fr
325236/51	36/51Fr



Femoral Venous Cannula

CE 0123

Code	Specification	Inner Diameter, mm
331117	17Fr	4.7
331119	19Fr	5.3
331121	21Fr	6.0



Femoral Venous Cannula (Multistage)

Code	Specification
33122429	24/29Fr
3313232525	23/25/25Fr

Femoral Arterial Cannula

Code	Specification	Inner Diameter, mm
311115	15Fr	4.1mm
311117	17Fr	4.7mm
311119	19Fr	5.3mm
311121	21Fr	5.8mm



Aortic Root Cannula

CE 0123

(Standard type)

With Suture Flange, a stainless-steel introducer needle, clean body.

Code	Specification	Length
35101	Adult	155mm
35102	Pediatric	150mm
35103	Infant	100mm
35104	Adult-Long	350mm
35105	Adult-Long	250mm



Aortic Root Cannula (Adult and Pediatric)



Aortic Root Cannula (Infant)



(Vent Line type)

With Suture Flange, a stainless-steel introducer needle, clean body. With vent line

w/ normal tube		
Code	Specification	Vent Line Position
35201	Adult	Patient End
35202	Pediatric	Patient End
35203	Adult	Machine End
35204	Pediatric	Machine End



(New Vent Line type)

With Suture Flange, a stainless-steel introducer needle, clean body. Special vent line far away from tip supplies good operation view for doctor.

w/ normal tube	
Code	Specification
35301	12G
35302	14G



Heart Aspirator

(Soft type)

Code	Specification
33201	Adult
33202	Pediatric



(Stainless Steel type)

Code	Specification
33401	Adult
33402	Pediatric
33403	Infant
33404	Mini Sucker

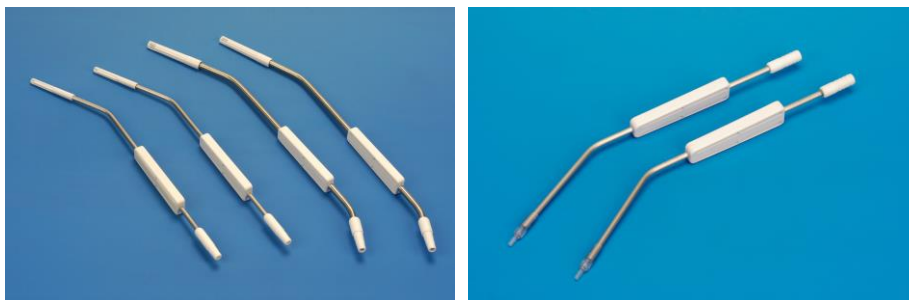

(Stainless Steel type new type)

Code	Specification
33301	Adult



Left Heart Catheter (Vent line)

(With Stylet)

Code	Specification
37104	18Fr



(Without Stylet)

Code	Specification
37101	16Fr
37102	18Fr
37103	20Fr



(Silicone, with Stylet)

Code	Specification
37401	14Fr
37402	16Fr
37403	20Fr



Double Lumen Left Heart Catheter

Code	Specification
37201	Adult
37202	Pediatric



Sump

Code	Specification
37301	Adult
37302	Pediatric



Vessel Cannula

Code	Specification	Size
3801	Free flow	3.0mm
3802	One-flow	3.0mm
3803	Free flow	2.0mm



Arteriotomy Cannula

Code	Specification	
	Tip	Length
3811	2mm	3.3cm
3812	2mm	5.8mm
3816	5mm	5.8cm



Coronary Artery Ostial Cannula

	45° tip	90° tip
Specification	Code	Code
10Fr	38101	38102
12Fr	38201	38202
14Fr	38301	38302



Cardioplegia Adapters

These products allow for simultaneous perfusion of the aortic root and up to three or more vein grafts. Standard Luer Inlet port and color clamps attached to an adapter which splits into four or more legs.

Code	Specification
39001	Y type
39002	5 ways
39003	6 ways
690101	1/4-Male Luer

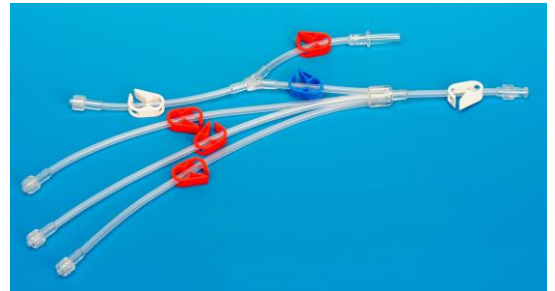
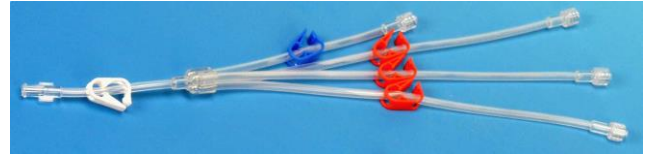
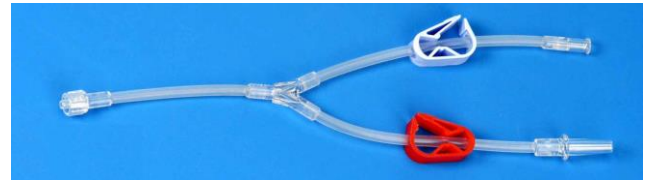

Note: We can produce different designs according to the customer's requirements.

Blower

Code
9001



Tourniquet

Code	Specification
3601	14 cm
3602	17.8 cm

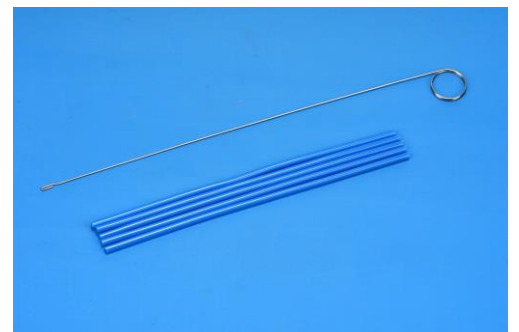

Blood Reservoir

Code	Specification
2221	2000ml
2222	3000ml



Extra-Corporeal Circuit Tube

CE 0123

Code	Specification
2101	Adult
2102	Pediatric
2103	Infant

Note: We can produce different designs of tubing pack according to the customer's requirements.



Cardioplegia Perfusion Set

Code	Specification
2201	Crystalloid
2202	Blood
2203	Customized
2204	With Stainless Steel Heat Exchanger
2205	With Aluminum Heat Exchanger



Note: We can produce different designs of tubing pack according to the customer's requirements.

Arterial Filter

Code	Specification	Maximum Flow rate (L/min)	Filtrate area (cm ²)	Filtrate size (µm)	Priming volume (mL)
2211	Adult	7.0	600	40	160
2212	Pediatric	3.0	300	40	100
2213	Infant	1.5	150	40	50
2214	Neonate	1.5	150	40	30

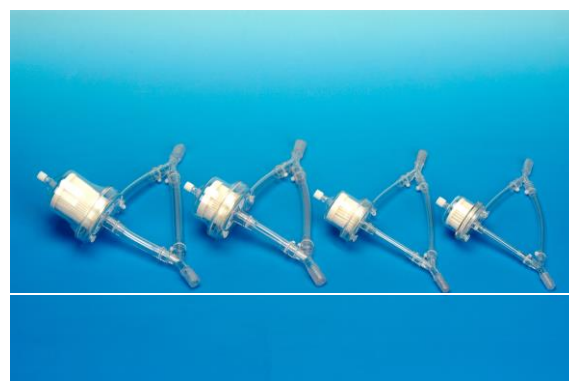

Temperature Controlling Blanket with Water Circulation

Code	Specification	Size
2601	Adult	1.50x0.55m
2602	Pediatric	1.20x0.55m
2603	Infant	1.00x0.55m



Suture Organizer

Code	Specification
6831	Adult
6832	Pediatric



Tubing Organizer

(Material: PE)

Code
6801

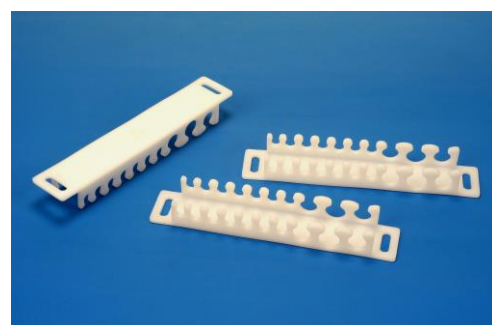

Stainless Steel Heat Exchanger

Code
2206

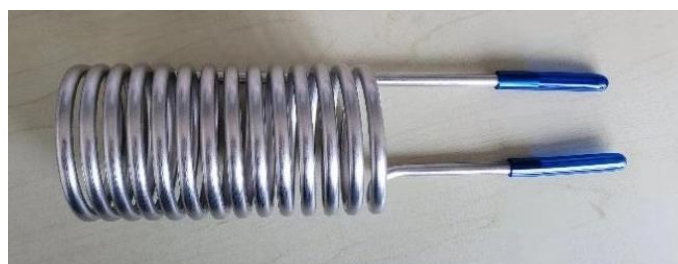

Isolator

(Clean PC, Disposable)

Code
2401



Level Sensor Pads

Code	Type
6811	Maquet-Jostra
6812	Terumo
6813	Sorin

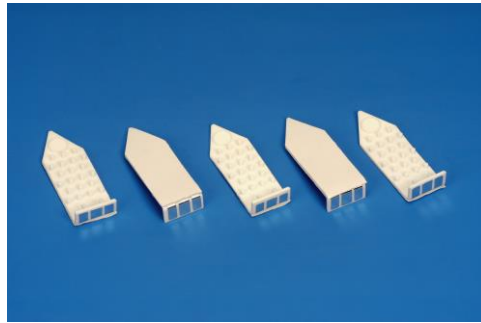

Maquet-Jostra

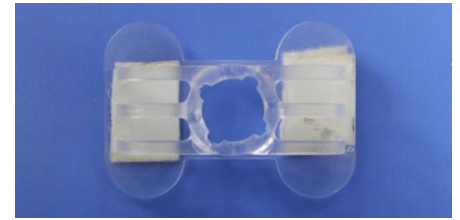

Terumo



Sorin

Clamp

Code	Specification
6601W	Large, White
6601R	Large, Red
6601B	Large, Blue
6602W	Middle, White
6602R	Middle, Red
6602B	Middle, Blue
6603W	Small, White
6603R	Small, Red
6604B	Small, Blue
6604Y	Small, Yellow



Spikes

Code	Specification
6821	Both ends
6822	w/o vent
6823	w/ vent

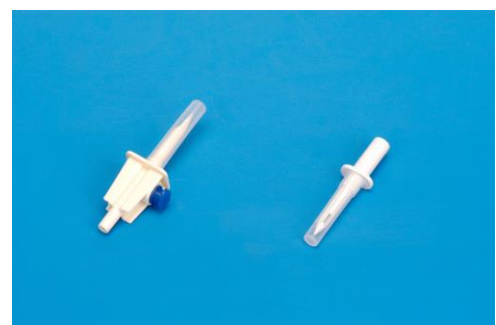

One Way Check Valve

Code	ID (Inlet and Outlet)	OD(Inlet and Outlet)
6501	1.8mm	3.3mm



Vacuum Relief Check Valve

Code	ID (Inlet and Outlet)	OD(Inlet and Outlet)
6502	1/4"	1/4"



Dialysis Luer Connector

Code	Specification
6401	Female, Red
6402	Female, Blue
6403	Male, Original Color



Tubing Cap

Color of Cap					Specification
Red	Blue	Yellow	Green	White	
Code	Code	Code	Code	Code	
6301R	6301B	6301Y	6301G	6301W	For 1/2 tubing
6302R	6302B	6302Y	6302G	6302W	For 1/2 connector
6303R	6303B	6303Y	6303G	6303W	For 3/8 tubing
6304R	6304B	6304Y	6304G	6304W	For 3/8 connector
6305R	6305B	6305Y	6305G	6305W	For 1/4 tubing
6306R	6306B	6306Y	6306G	6306W	For 1/4 connector
6307R	6307B	6307Y	6307G	6307W	For 1/8 tubing
6308R	6308B	6308Y	6308G	6308W	For 3/16 connector



Connector

(Material: Clean PC)

Code	Specification	Description
610101	1/2x1/2	Straight connector
610102	1/2x3/8	
610103	3/8x3/8	
610104	3/8x1/4	
610105	1/4x1/4	
610106	1/4x3/16	
610107	3/16x3/16	
610108	1/8x1/8	
610201	1/2x3/8x3/8	Y connector
610202	1/2x1/4x1/2	
610203	3/8x3/8x3/8	
610204	3/8x1/4x1/4	
610205	1/4x1/4x1/4	
610206	1/2x1/2x1/2	
610207	1/2x3/8x1/2	
610208	3/16x3/16x3/16	
610209	1/4x3/8x3/8	
610210	3/8x1/4x3/8	
610211	1/8x1/8x1/8	
610212	1/2x3/8x1/4	
620101	1/2x3/8LL	T connector (Luer lock)
620102	3/8x3/8LL	
620103	3/8x1/4LL	
620104	1/4x1/4LL	
620105	1/2x1/2LL	
620106	3/16x3/16LL	
620107	1/4x3/16LL	
620201	3/8x3/8x3/8LL	4-way connector (Luer lock)
620202	1/2x1/2x1/2LL	
620203	1/4x1/4x1/4LL	
620204	3/16x3/16x3/16LL	
620205	3/8x1/4x3/8LL	
620206	3/8x1/4x1/4LL	
620207	1/2x3/8x3/8LL	
620208	1/2x3/8x1/2LL	
690201	1/4-Spike Connector	
690301	6-3-Male Luer Y Connector	
6904	1/2x1/2 Blood Oxygen Saturation Connector	
6905	3/8x3/8 Blood Oxygen Saturation Connector	
620301	1/2x1/2 w/ Double Luer	
620302	3/8x3/8 w/ Double Luer	
620303	1/4x1/4 w/ Double Luer	



Pre-bypass Filter

(Material: Clean PC)

Code	Inlet	Outlet
6401	3/8	1/2
6402	3/8	3/8
6403	1/4	3/8



Dynamic Bubble Trap (DBT)

Code
6001



Gas Filter

(Material: Clean PP)

Code	Inlet	Outlet	Filter Size
6701	1/4	1/4	0.45µm
6702	1/4	1/4	0.22µm



Pressure Transducer

Code	Compatible with	Code	Compatible with	Code	Compatible with
Single		Double		Triple	
8601	Edwards	8601B	Edwards	8601C	Edwards
8602	Utha	8602B	Utha	8602C	Utha
8603	Argon	8603B	Argon	8603C	Argon
8604	Abbot	8604B	Abbot	8604C	Abbot
8605	BD	8605B	BD	8605C	BD
8606	B. Braun/Philips	8606B	B. Braun/Philips	8606C	B. Braun/Philips



Inflation Device

Code	Specification
80001	20ml
80002	25ml



Control Syringe

Code
84001



Y Hemostasis Valve Kit

Code	Structure
85001	Click
85002	Pull-Push
85003	Screw



ANAESTHESIA & RESPIRATION PRODUCTS

Closed Suction Catheter

Code	Spec.	O.D. mm	I.D. mm	Length mm	Color Mark
4205	5Fr	1.7	0.9	300	Grey
4206	6Fr	2.0	1.4	300	Pea Green
4207	7Fr	2.3	1.3	300	Purple
4208	8Fr	2.7	1.8	300	Cambridge Blue
4210	10Fr	3.3	2.4	600	Black
4212	12Fr	4.0	2.8	600	White
4214	14Fr	4.7	3.2	600	Green
4216	16Fr	5.3	3.8	600	Orange



CE₀₁₂₃

Characteristics of the product:

- (1) Ventilator can supply oxygen to the patient non-stop.
- (2) Connectors to ETT and ventilator can be rotated freely for different positions.
- (3) Completed closed suction system is equipped.
- (4) Suction valve can be locked when not in use.

Instruction for use:

- (1) Choose suitable specifications according to patient.
- (2) Inspect the product before use. Do not use when the package is not intact.
- (3) Open the package and take the product out.
- (4) Connect endotracheal tube/tracheostomy tube/laryngeal mask airway.
- (5) Connect ventilator.
- (6) Open the on-off valve and keep the two irrigation ports closed before suction.
- (7) Grip T connector by one hand and insert the suction catheter to endotracheal tube/tracheostomy tube/laryngeal mask airway to suitable depth with the other hand.
- (8) Press suction valve for suction.
- (9) After use, remove the suction catheter. Close the on-off valve.
- (10) Open irrigation port. Inject sterile water to clean catheter tip.

Laryngeal Mask Airway

(Silicone Non-Reinforced tube, Disposable)

Code	Specification	Patient weight
460310	1.0#	<5kg
460315	1.5#	5-10kg
460320	2.0#	10-20kg
460325	2.5#	20-30kg
460330	3.0#	30-50kg
460340	4.0#	50-70kg
460350	5.0#	>70kg



(Silicone Reinforced tube, Disposable)

Code	Specification	Patient weight
460510	1.0#	<5kg
460515	1.5#	5-10kg
460520	2.0#	10-20kg
460525	2.5#	20-30kg
460530	3.0#	30-50kg
460540	4.0#	50-70kg
460550	5.0#	>70kg



Code	Specification	Patient weight
460410	1.0#	<5kg
460415	1.5#	5-10kg
460420	2.0#	10-20kg
460425	2.5#	20-30kg
460430	3.0#	30-50kg
460440	4.0#	50-70kg
460450	5.0#	>70kg

(Silicone Non-Reinforced tube, Reusable)

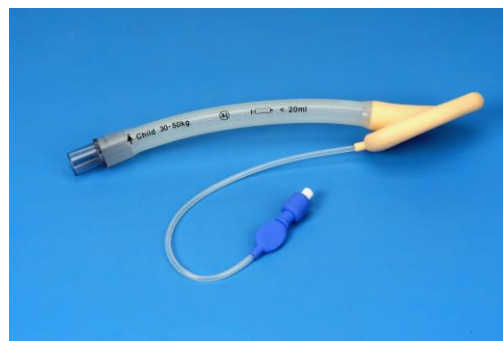

(Silicone Reinforced tube, Reusable)

Code	Specification	Patient weight
460610	1.0#	<5kg
460615	1.5#	5-10kg
460620	2.0#	10-20kg
460625	2.5#	20-30kg
460630	3.0#	30-50kg
460640	4.0#	50-70kg
460650	5.0#	>70kg



Laryngeal Mask Airway

(PVC Non-Reinforced tube, Disposable)

Code	Specification	Patient weight
460110	1.0#	<5kg
460115	1.5#	5-10kg
460120	2.0#	10-20kg
460125	2.5#	20-30kg
460130	3.0#	30-50kg
460140	4.0#	50-70kg
460150	5.0#	>70kg



Endotracheal Tube with Suction Lumen

Reinforced Code	Non-Reinforced Code	Specification
41560	41660	6.0
41565	41665	6.5
41570	41670	7.0
41575	41675	7.5
41580	41680	8.0
41585	41685	8.5
41590	41690	9.0
41595	41695	9.5



Reinforced Silicone Endotracheal Tube

Code	Specification
41765	6.5
47170	7.0
41775	7.5
41780	8.0



Intubation Stylet

Code	Specification
41906	6Fr
41910	10Fr
41914	14Fr

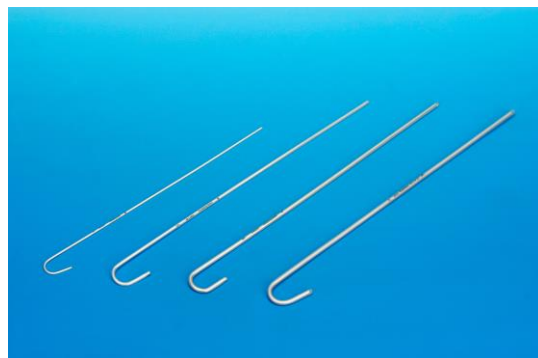

Reinforced Endotracheal Tube

Reinforced Endotracheal Tube Cuffed	Reinforced Endotracheal Tube Non-Cuffed	
Code	Code	Specification
41120	41320	2.0
41125	41325	2.5
41130	41330	3.0
41135	41335	3.5
41140	41340	4.0
41145	41345	4.5
41150	41350	5.0
41155	41355	5.5
41160	41360	6.0
41165	41365	6.5
41170	41370	7.0
41175	41375	7.5
41180	41380	8.0
41185	41385	8.5
41190	41390	9.0
41195	41395	9.5
411100	413100	10.0

10pcs/box 10boxes/carton



Cuffed



Non-Cuffed

Endotracheal Tube

Endotracheal Tube Cuffed	Endotracheal Tube Non-Cuffed	
Code	Code	Specification
41220	41420	2.0
41225	41425	2.5
41230	41430	3.0
41235	41435	3.5
41240	41440	4.0
41245	41445	4.5
41250	41450	5.0
41255	41455	5.5
41260	41460	6.0
41265	41465	6.5
41270	41470	7.0
41275	41475	7.5
41280	41480	8.0
41285	41485	8.5
41290	41490	9.0
41295	41495	9.5
412100	414100	10.0

10pcs/box 10boxes/carton



Cuffed and Non-Cuffed



Endotracheal Tube Preformed Nasal

Normal Cuffed	Normal Non-Cuffed	
Code	Code	Specification
412220	412420	2.0
412225	412425	2.5
412230	412430	3.0
412235	412435	3.5
412240	412440	4.0
412245	412445	4.5
412250	412450	5.0
412255	412455	5.5
412260	412460	6.0
412265	412465	6.5
412270	412470	7.0
412275	412475	7.5
412280	412480	8.0
412285	412485	8.5
412290	412490	9.0
412295	412495	9.5
4122100	4124100	10.0

10pcs/box 10boxes/carton



Endotracheal Tube Preformed Oral

Normal Cuffed	Normal Non-Cuffed	
Code	Code	Specification
412120	412320	2.0
412125	412325	2.5
412130	412330	3.0
412135	412335	3.5
412140	412340	4.0
412145	412345	4.5
412150	412350	5.0
412155	412355	5.5
412160	412360	6.0
412165	412365	6.5
412170	412370	7.0
412175	412375	7.5
412180	412380	8.0
412185	412385	8.5
412190	412390	9.0
412195	412395	9.5
4121100	4123100	10.0

10pcs/box 10boxes/carton



Breathing Circuit Tube

Code	Specification
44102	Smooth bore, Adult
44103	Expandable, Adult
44104	Corrugated, Adult
44202	Smooth bore, Pediatric
44203	Expandable, Pediatric
44204	Corrugated, Pediatric
44401	Coaxial
44501	Double Lumen

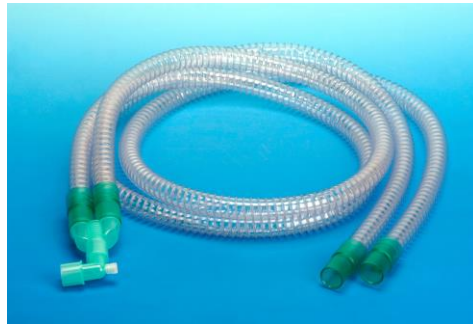

Anaesthesia Machine Connecting Tube

Silicone, Reusable, Different lengths according to the customer's requirements

Code	Specification
4409030	ID9mm×30cm
4409060	ID9mm×60cm
4409120	ID9mm×120cm
4415030	ID15mm×30cm
4415060	ID15mm×60cm
4415120	ID15mm×120cm
4420030	ID20mm×30cm
4420060	ID20mm×60cm
4420120	ID20mm×120cm



Note: We can produce different silicone lengths according to the customer's requirements. If you cannot find your size from list above, please contact sales to order special length.

Catheter Mount

Code	Specification
44302	Disposable, Expandable, straight
44303	Disposable, Corrugated, straight
44304	Disposable, Smooth bore, straight
44305	Disposable, Expandable, Swivel
44306	Disposable, Corrugated, Swivel
44307	Disposable, Smooth bore, Swivel
44308	Disposable, Expandable, Curved
44309	Disposable, Corrugated, Curved
44310	Disposable, Smooth bore, Curved



Oxygen Filter

Code	Specification
6703	w/ Vent
6704	HME, w/ Vent



Water Trap

Code	Specification
440011	Adult, Reusable
440012	Pediatric, Reusable
440013	Adult, Disposable
440014	Pediatric, Disposable



Y Connector for Anaesthesia Machine Connecting Tube

Code	Specification
440021	Adult, Reusable
440022	Pediatric, Reusable
440031	Adult, Y Type, Disposable, w/ Vent
440032	Adult, Y Type, Disposable, w/o Vent
440033	Adult, U Type, Disposable, w/ Vent
440034	Adult, U Type, Disposable, w/o Vent
440041	Pediatric, Y Type, Disposable, w/ Vent
440042	Pediatric, Y Type, Disposable, w/o Vent
440043	Pediatric, U Type, Disposable, w/ Vent
440044	Pediatric, U Type, Disposable, w/o Vent



Breathing Bag

Specification		Code
Latex, Blue	0.25L	78101
	0.5L	78102
	1L	78103
	2L	78104
	3L	78105
Latex, Gray	0.25L	78201
	0.5L	78202
	1L	78203
	2L	78204
	3L	78205
Latex, Black	0.25L	78301
	0.5L	78302
	1L	78303
	2L	78304
	3L	78305
Latex Free, Green	0.25L	78401
	0.5L	78402
	1L	78403
	2L	78404
	3L	78405
Silicone	1L	78503
	2L	78504
	3L	78505
Latex, Black, w/ bag line	0.25L	78601
	0.5L	78602
	1L	78603
	2L	78604
	3L	78605
Latex Free, Black, w/ bag line	0.25L	78701
	0.5L	78702
	1L	78703
	2L	78704
	3L	78705



Latex



Latex-Free



Silicone



w/ bag line

Central Venous Catheter

Code	Specification
430101	Single Lumen 20Gax13cm
430102	Single Lumen 20Gax20cm
430103	Single Lumen 18Gax15cm
430104	Single Lumen 18Gax20cm
430105	Single Lumen 18Gax30cm
430106	Single Lumen 16Gax15cm
430107	Single Lumen 16Gax20cm
430108	Single Lumen 16Gax30cm
430109	Single Lumen 14Gax15cm
430110	Single Lumen 14Gax20cm
430111	Single Lumen 14Gax30cm
430201	Double Lumen 4Fr×5cm
430202	Double Lumen 4Fr×8cm
430203	Double Lumen 4Fr×13cm
430204	Double Lumen 5Fr×8cm
430205	Double Lumen 5Fr×13cm
430206	Double Lumen 5Fr×20cm
430207	Double Lumen 7Fr×15cm
430208	Double Lumen 7Fr×20cm
430209	Double Lumen 7Fr×30cm
430210	Double Lumen 7Fr×50cm
430301	Triple lumen 5.5Fr×8cm
430302	Triple lumen 5.5Fr×13cm
430303	Triple lumen 7Fr×15cm
430304	Triple lumen 7Fr×20cm
430305	Triple lumen 7Fr×30cm



Neurosurgical Products

External Ventricular Drainage Device

Application Scope:

- Drainage for intracranial hemorrhage
- Drainage for intracranial infection
- Drainage after intracranial tumor surgery
- Catheter intubation before some surgery to reduce intracranial pressure
- Acute hydrocephalus caused by brainstem hemorrhage or cerebellar hemorrhage entering encephalocele.
- Drainage for Subdural hematoma or epidural hematoma

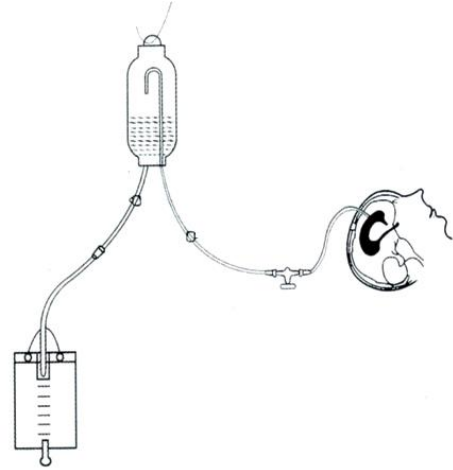

Type I

Code	Specification
5201	9Fr, simple package
5202	9Fr, composite package

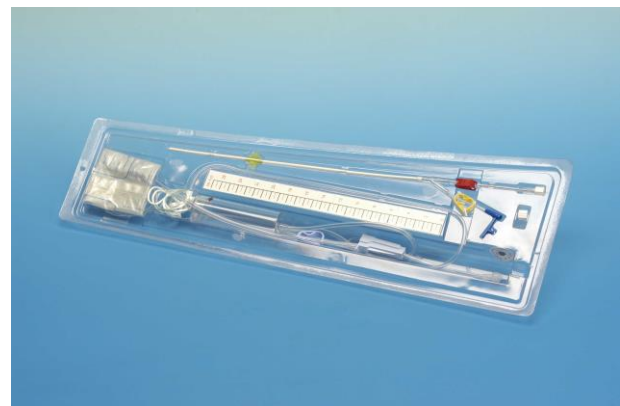

Simple Package

Components:

- Drainage catheter with vent
- Connection tubing
- Flow regulator
- Drainage chamber
- Collection bag
- Tubing clamp
- Catheter clamp
- Ruler



Characteristic:

- Catheter is made of PU with high rigidity, thin wall, high flow, smooth, good biocompatibility, blind end, less harm, radiopaque line.
- Catheter has a vent to supply perfect test platform. Drainage and continuous intracranial pressure test (or medicine supply) can be performed simultaneously.
- Drainage chamber and collection bag has a tick mark to measure the volume of liquid conveniently. It is equipped with a gas filter.
- The collection bag has a one way valve to avoid infection.



Composite Package

External Ventricular Drainage Device

Type II

Code	Specification
5301	10Fr, simple package
5302	10Fr, composite package
5303	14Fr, simple package
5304	14Fr, composite package

Components:

- Drainage catheter
- Extension line with stopcock
- Connection tubing
- Flow regulator
- Drainage chamber
- Collection bag
- Tubing clamp

Characteristic:

- Catheter is made of medical silicone with blue radiopaque line, blind end.
- Drainage chamber is equipped with gas filter to avoid contra-flow and siphonage.
- Drainage chamber and collection bag has a tick mark to measure the volume of liquid conveniently. It is equipped with a gas filter.
- The collection bag has a one way valve to avoid infection.
- Hypodermic needle and cranial awl can be equipped if needed.



Components



Simple Package



Composite Package

Lumbar Cistern Drainage Device

Application Scope:

- subarachnoid hemorrhage
- ventricular hemorrhage
- intracranial infection

Contraindication:

- Hernia cerebri
- Intracranial pressure rises obviously.
- Skin or soft tissue is infected at puncture place.
- Lumbar vertebra deformity or sclerotin damage
- Systemic serious infection (hematosepsis), shock or almost clinical shock
- Patient is restless or uncooperative.
- Compression lesion of medulla spinalis
- Be more serious after Lumbar puncture.
- Obstruction of cerebrospinal fluid circuit

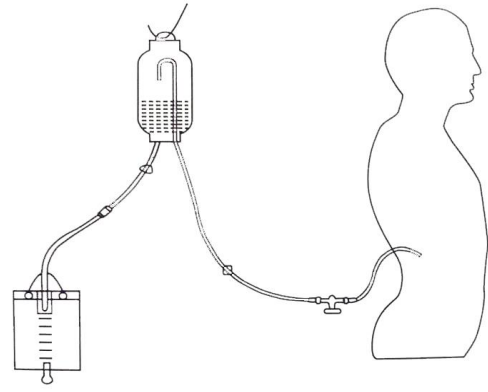

Components

Code	Specification
5401	4Fr, simple package
5402	4Fr, composite package

Components:

- Drainage catheter
- Puncture needle
- Syringe
- Heparin cap
- Connector
- Stopcock
- Collection bag with connection tubing
- Drainage chamber
- Towel with hole
- Glove
- Dressing
- Cotton ball



Puncture Kit
Simple Package



Drainage Kit

Characteristic:

- Advantage of the treatment: small wound, drainage flow can be controlled, remove bleeding more thoroughly, better biocompatibility, lower infection, more convenient treatment and test of cerebrospinal fluid.
- Puncture kit: catheter is made of composite material with proper hardness, smooth surface, tick mark for insertion depth, eight holes for drainage flow, round end and good biocompatibility.
- Drainage kit: drainage chamber is equipped with gas filter to avoid contra-flow and siphonage, drainage chamber and collection bag has a tick mark, the collection bag has a one-way valve to avoid infection.



Composite Package

General Surgical Products

Dressing

Specification	Code
Transparent Semi-Permeable For IV	A0607DSU
	A0607X
	A0607XU
	A0607U
Transparent Island	B0607DS
	B0607X
	B0607
Non-woven For wound	C0607
	C0910
	C0915
	C1015
Non-woven For IV	C0708U
	C0709U

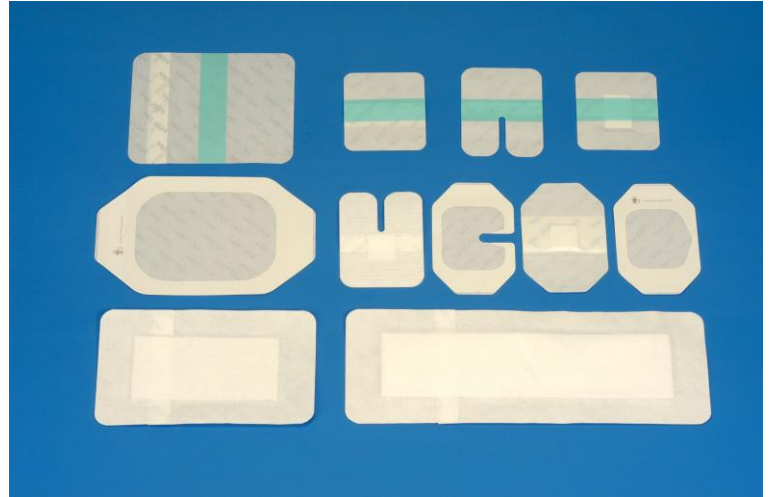

Yankauer Suction Handle

(Material: K-Resin)

Code	Tip	Control Valve	w/ Suction Tubing
9101	Crown	yes	9201
9102	Crown	no	9202
9103	Plain	yes	9203
9104	Plain	no	9204



Pressure Monitor Extension Line

CE 0123

Code	Length (cm)
4501030	30 without stopcock
4501100	100 without stopcock
4501150	150 without stopcock
4502030	30 with stopcock
4502100	100 with stopcock
4502150	150 with stopcock



Note: We can produce different lengths according to the customer's requirements. If you cannot find your size from list above, please contact sales to order special length.

Pressure Monitor Extension Line for Radiology

Code	Specification
4503	With one way valve
4504	Double Way



EMG Endotracheal Tube

Code	Specification
41060	6.0
41065	6.5
41070	7.0
41075	7.5
41080	8.0

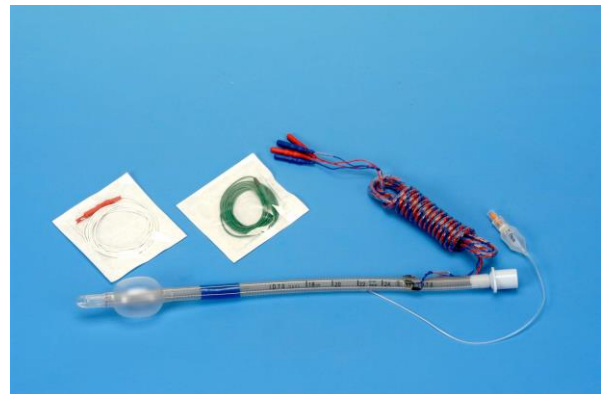

Rapid Self-retaining Nasal Kit

Code	Nasal Type	Code	Sinus Type
9201	1#, Pediatric	9301	1#, Pediatric
9202	2#, Adult Female	9302	2#, Adult
9203	3#, Adult Male	9303	3#, Adult
9204	4#, Adult with wide nasal cavity		

